

R EV.	DESCRIPTION	DRAWN	CHECKED	APPROVED
A	NEW RELEASE	LJH 05/09/05'		

NOTES:

- SPECIFICATION
 - CURRENT RATING: 5A Max.
 - DIELECTRIC WITH STANDING VOLTAGE: 500V(AC)
 - CONTACT RESISTANCE: 50mΩ Max.
 - INSULATION RESISTANCE: 1000MΩ(DC)Min
- PRODUCT NUMBER CODE:

BR 08034-

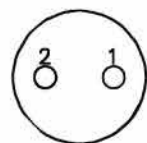
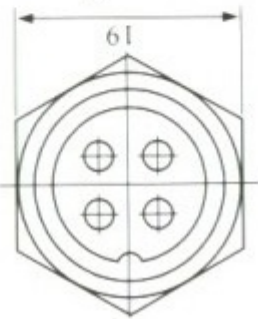
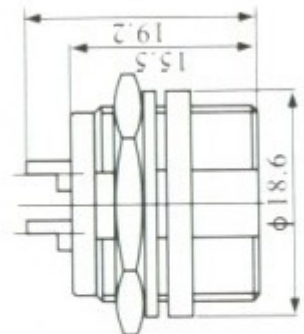
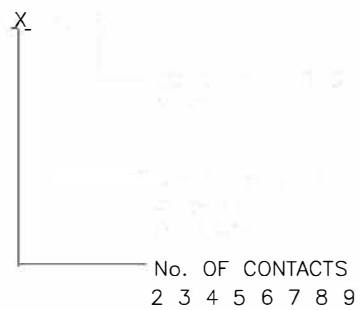

2 PIN

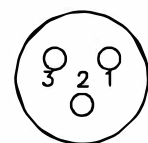

3 PIN

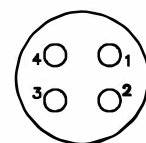

4 PIN

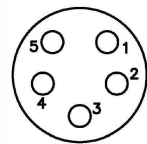

5 PIN

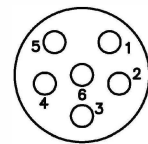

6 PIN

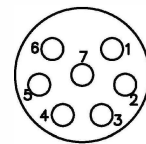

7 PIN

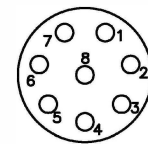

8 PIN

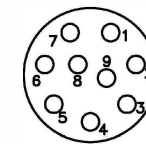

9 PIN



GENERAL TOLERANCE	ANGLE TOLERANCE	PROJECTION	TITLE
X. ±0.60	X. ±5°	UNITS mm	MICRO JACK CONNECTOR MALE
.X ±0.38	.X ±3°	SHEET SIZE A4	SERIES BR 08034
.XX ±0.25	.XX ±2°		
DRAWING TYPE	CUSTOMER		
SCALE	1:1	SHEET	1 OF 1
DRAWING NO.			

