

REV.	DESCRIPTION	DRAWN	CHECKED	APPROVED
A	NEW RELEASE	LJH 12/20/05'	~	LJC 12/20/05'
B	整理图面	YCH 09/14/07'	~	

NOTES:

1. PART NUMBER CODE:

DS1048 - 09 X X X X

- Bolt type  
L: Long  
S: Short
- Packing type  
1: Mix packing  
2: Separation packing
- Cover Material  
P: Plastic(ABS)
- Cover Color  
A: Gray  
B: Black  
V: Ivory
- Position  
09: 9pin

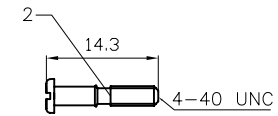
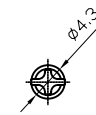
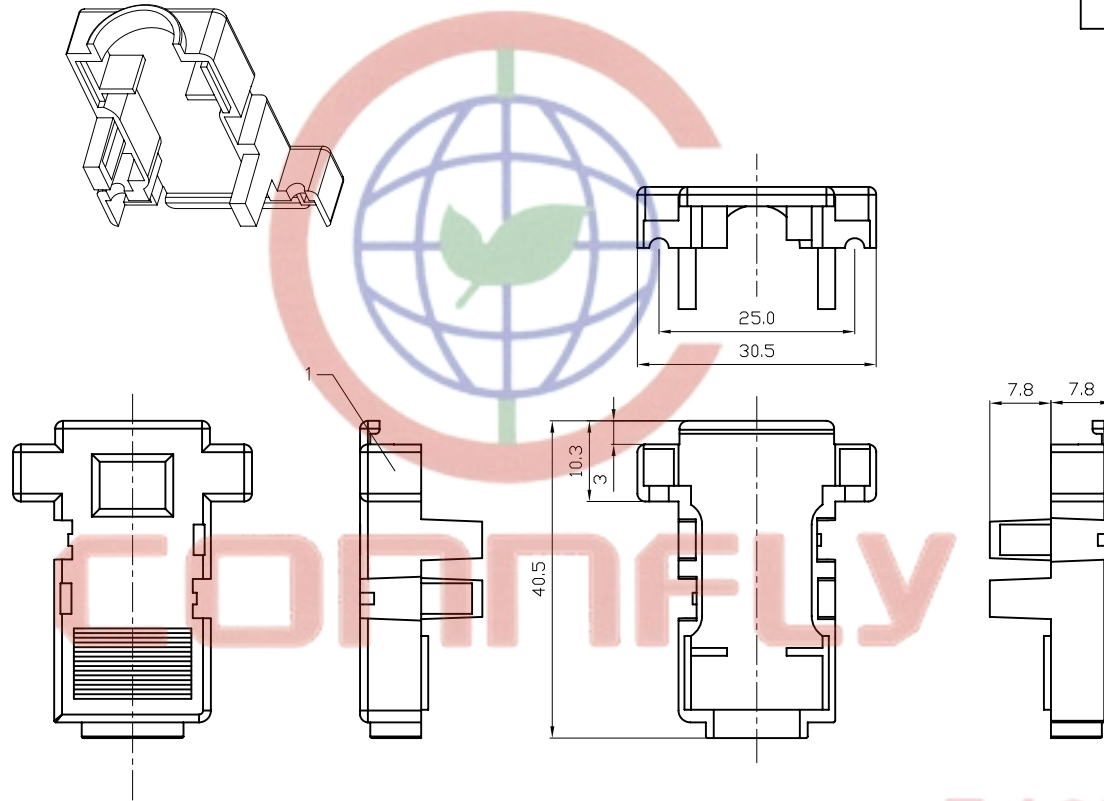

Short BOLT

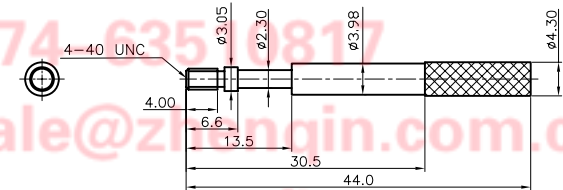

Long BOLT

BOM LIST			
ITEM	PART NAME	Q'ty	NOTES
1	PLASTIC HOOD	2	ABS
2	BOLT	2	#4-40

Tel:86-574-63508787

Fax:86-574-6350817

E-mail:sale@zhangpin.com.cn

Http://www.connfly.com

GENERAL TOLERANCE		ANGLE TOLERANCE		PROJECTION	TITLE
X.	±0.60	X.	±5°	mm	PLASTIC FROM THE LOCK TYPE
.X	±0.38	.X	±3°		
.XX	±0.25	.XX	±2°		
DRAWING TYPE		COSTOMER		SHEET SIZE	SERIES
SCALE		1:1	SHEET	A4	DS1048 SERIES
DRAWING NO.		C-DS1048-09XXXX		<b>晨翔电子有限公司</b> <b>CONNFLY CONNFLY ELECTRONIC CO. LTD</b>	

REV.	DESCRIPTION	DRAWN	CHECKED	APPROVED
A	NEW RELEASE	LJH 12/20/05'	~	LJC 12/20/05'
B	整理图面	YCH 09/14/07'	~	

NOTES:

1. PART NUMBER CODE:

DS1048 - 25 X X X X

Bolt type  
L: Long  
S: Short

Packing type  
1: Mix packing  
2: Separation packing

Cover Material  
P: Plastic(ABS)

Cover Color  
A: Gray  
B: Black  
V: Ivory

Position  
25: 25pin

BOM LIST			
ITEM	PART NAME	Q'ty	NOTES
1	PLASTIC HOOD	2	ABS
2	BOLT	2	#4-40

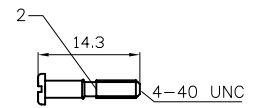
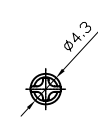
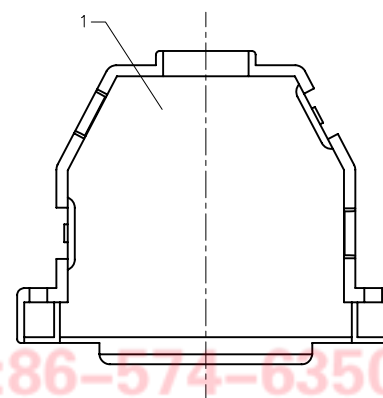
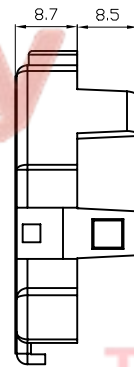
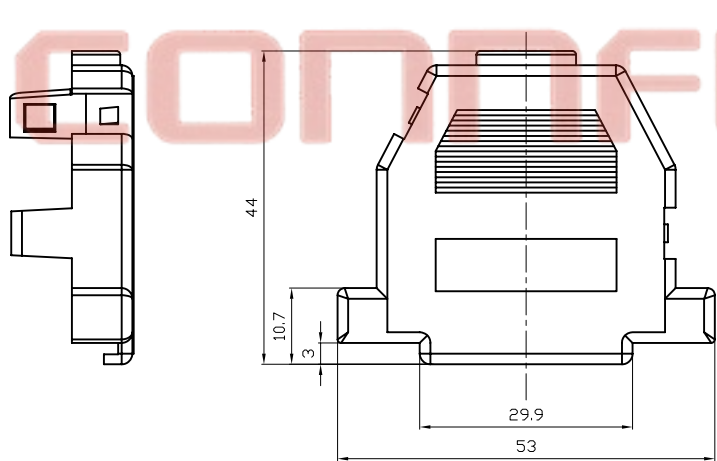
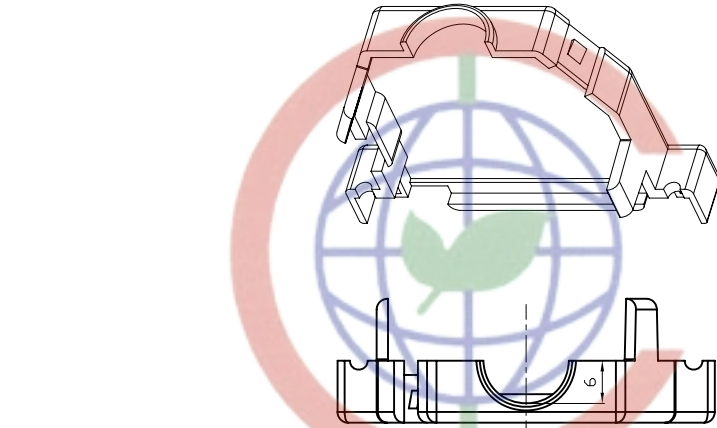

Short BOLT

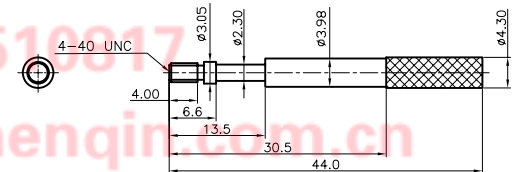

Long BOLT

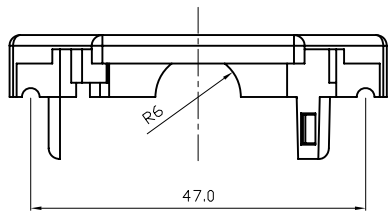

GENERAL TOLERANCE		ANGLE TOLERANCE		PROJECTION	TITLE
X.	±0.60	X.	±5°	mm	PLASTIC FROM THE LOCK TYPE
.X	±0.38	.X	±3°	A4	SERIES DS1048 SERIES
.XX	±0.25	.XX	±2°		
DRAWING TYPE	COSTOMER		晨翔电子有限公司		
SCALE	1:1	SHEET	1 OF 1		
DRAWING NO.	C-DS1048-25XXXX		CONNFLY CONNFLY ELECTRONIC CO. LTD		