

Catálogo Breda

Linha completa de conectores



A Empresa

A BREDÁ CONECTORES foi criada tendo em vista suprir a necessidade de seus clientes nas áreas de Desenvolvimento, Comercialização de conectores e LEDs. Visando ao melhor atendimento e contando com uma estrutura de relacionamento internacional, detém distribuição autorizada de marcas de renome, são elas: EXCON, CONNFLY, KEFA, BRCONN, OPTOBR, etc.



Distribuimos conectores de vários segmentos: AUTOMOTIVOS, LINHA BRANCA, SEGURANÇA, EQUIPAMENTOS HOSPITALARES, TELECOM, ELEVADORES, dentre outros. Dispomos de um amplo estoque físico e contamos com uma equipe especializada para melhor atendê-lo.

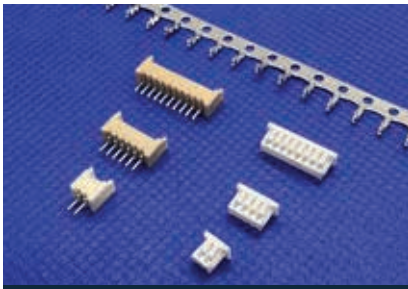

1251
CONECTORES PASSO 1,25 mm

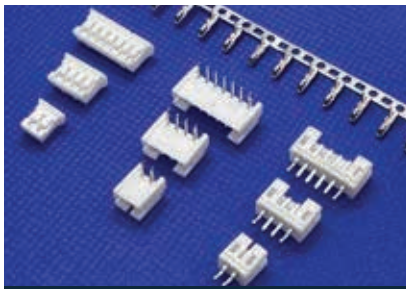

2001
CONECTORES PASSO 2,0 mm
(Equivalente JST PH)

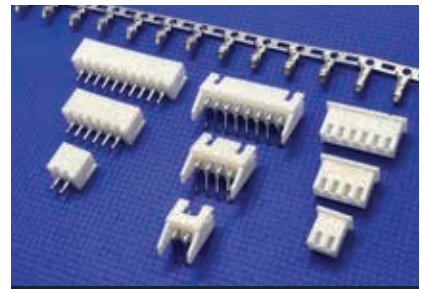

2501
CONECTORES PASSO 2,5 mm
(Equivalente JST XH)

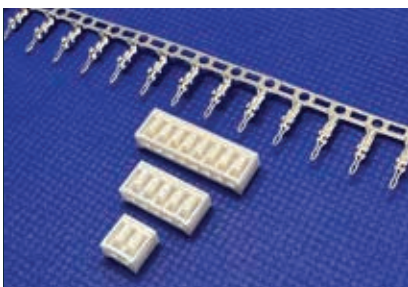

2502
CONECTORES PASSO 2,5 mm
(Equivalente JST SCN)

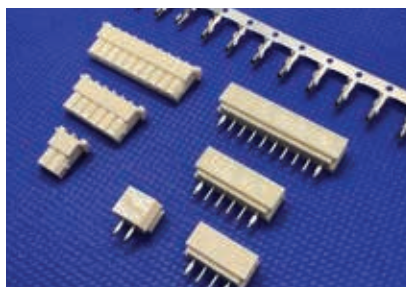

2503
CONECTORES PASSO 2,5 mm
(Equivalente Molex 5264/5263)



2507
CONECTORES PASSO 2,5 mm
(Equivalente JST SMR)

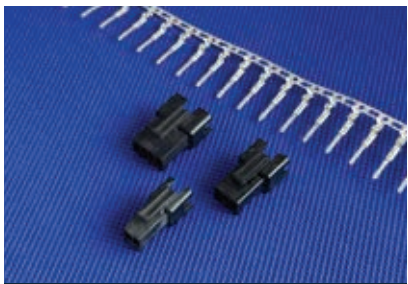

2508
CONECTORES PASSO 2,5 mm
(Equivalente JST SMP)

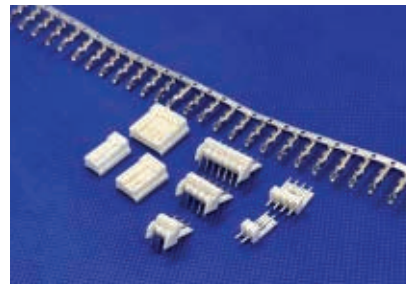

2510
CONECTORES PASSO 2,5 mm
(Equivalente EIS)

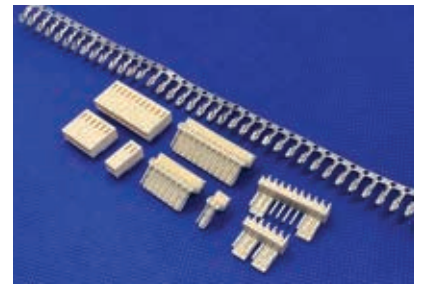

2512
CONECTORES PASSO 2,5 mm
(Equivalente KK 2,5m)

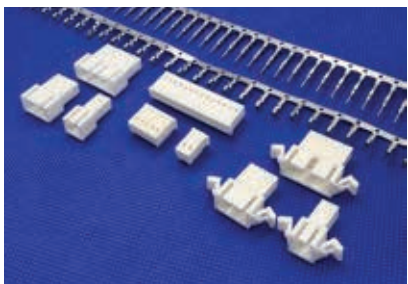

2513
CONECTOR PASSO 2,5 mm
(Equivalente SPOX)



2542 E 2543
CONECTOR PASSO 2,54 mm
(Equivalente MODU)

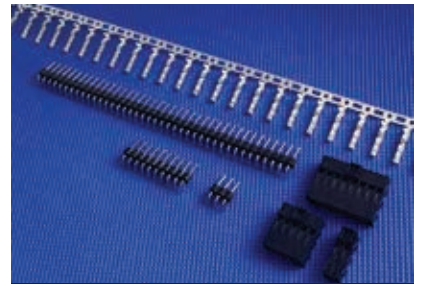

2544
CONECTORES PASSO 2,54 mm

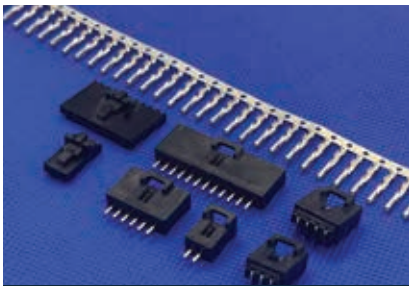

2545
CONECTORES PASSO 2,54 mm

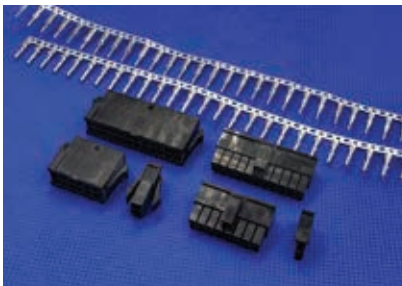

3001
CONECTORES PASSO 3,00 mm
(Equivalente ao MICRO FIT)

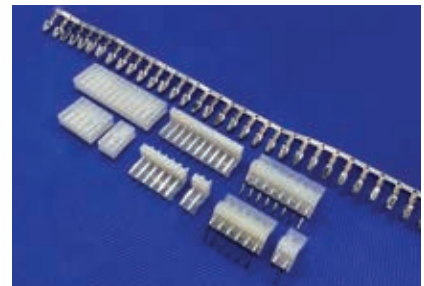

3961
CONECTORES PASSO 3,96 mm
(Equivalente ao KK 3,96 mm)



3962
CONECTORES PASSO 3,96 mm
(Equivalente ao JST VH)

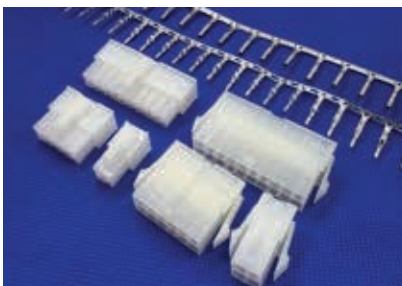

4201
CONECTOR PASSO 4,2 mm
(Equivalente ao MINI FIT)

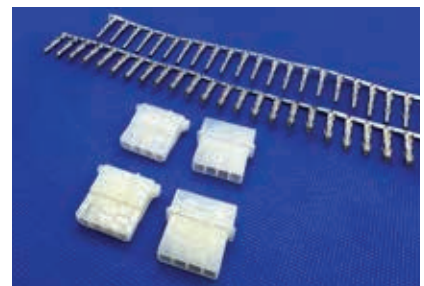

5081-5082
CONECTORES PASSO 5,08mm

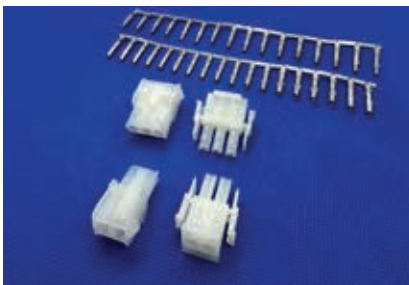

6605
CONECTORES PASSO 6,35 mm
(Equivalente ao MATE-N-LOCK)

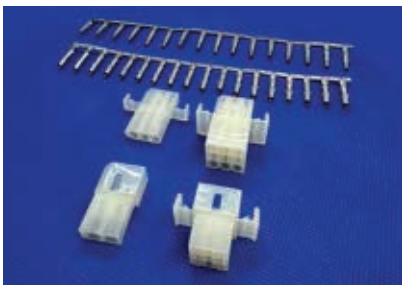

6607
CONECTORES PASSO 5,03 mm
(Cabo a Cabo)

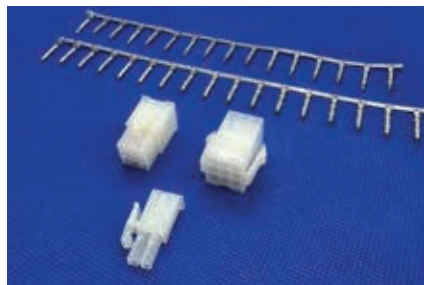

6608
CONECTORES PASSO 4,14 mm

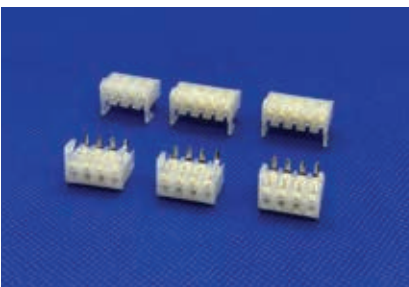

7702
CONECTORES PASSO 3,96 mm

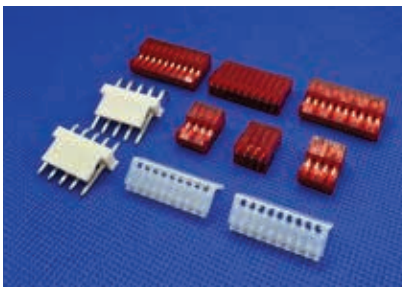

7804
CONECTORES PASSO 2,54mm
(Equivalente ao MTA)

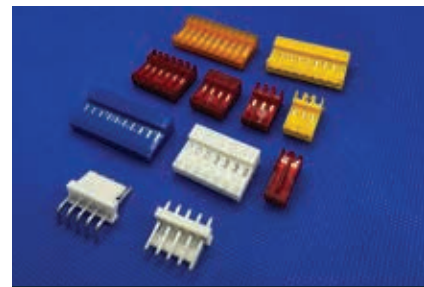

7805
CONECTOR PASSO 3,96 mm
(Equivalente ao MTA)

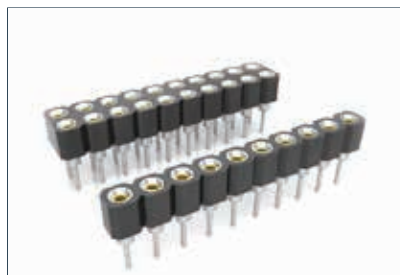

DS1002-01
BARRA DE SOQUETE
TORNEADO



DS1011
CONECTOR PIN HEADER 2,54mm
COM EJETOR 10 A 64 PINOS



DS1013
CONECTORES BOX HEADER
2,54mm
10 A 64 PINOS



DS1016
CONECTORES IDC SOCKET
2,54mm
10 A 68 PINOS

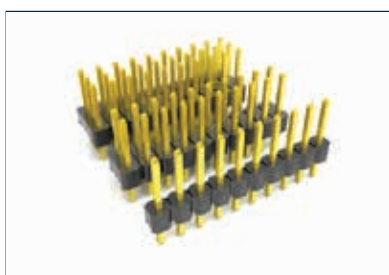

DS1021
BARRA DE PINOS PASSO 2,54mm
180 GRAUS

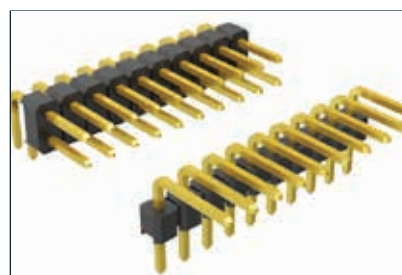

DS1022
BARRA DE PINOS PASSO 2,54mm
90 GRAUS

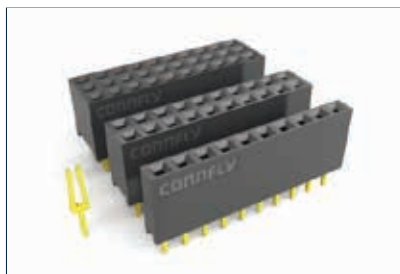

DS1023
CONECTOR PASSO 2,54mm
FÊMEA (EQUIVALENTE A MCI)
180 GRAUS



DS1025-01
BARRA DE PINOS 2,0mm
180 GRAUS



DS1025-05
BARRA DE PINOS 2,0mm
180 GRAUS

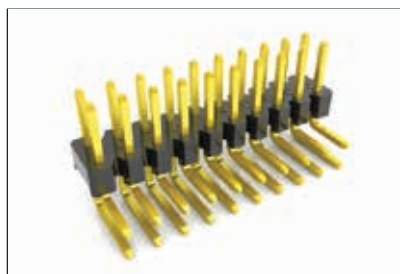

DS1025-06
BARRA DE PINOS 2,0mm
90 GRAUS

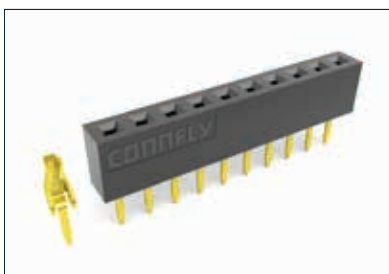

DS1026
CONECTOR PASSO 2,0mm
FÊMEA 180 GRAUS



DS1027
JUMPER COM E SEM HASTE
PASSO 2,54mm



DS1029-01
BARRA DE PINOS 2.54mm
COM ESPAÇADOR



DS1032
SOQUETE PLCC



DS1033
CONECTORES DB SOLDA FIO



DS1034
CONECTORES DB SOLDA
PLACA 180 GRAUS



DS1035
CONECTORES HD SOLDA FIO



DS1036
CONECTORES DB PARA FLAT
CABLE



DS1037
CONECTORES DB SOLDA
PLACA 90 GRAUS

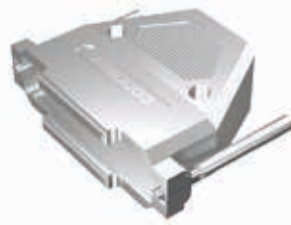

DS1045
CAPA PLASTICA P/ DB KIT
CURTO OU LONGO



DS1045-01
KIT DE RETENÇÃO FÊMEA
PARA DB



DS1047
CAPA METALICA P/ DB KIT
CURTO OU LONGO

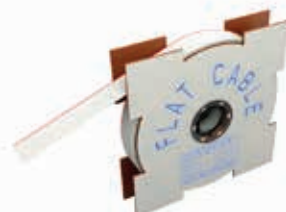

DS1057
FLAT CABLE CINZA PARA
CONECTORES PASSO 2,54mm
E 2,0mm



DS1066
CONECTOR PLACA-CABO
PASSO 2.0mm



DS1068
CONECTOR PLACA PASSO
2.5mm
 (Equivalente JST-SCN)



DS1068-02
CONECTOR CABO A CABO
PASSO 2,5mm
 (Equivalente JST-SMP/SMR)



DS1069
CONECTOR PLACA-CABO
PASSO 2.5mm
 (Equivalente JST XH)



DS1070
CONECTOR PLACA-CABO
PASSO 2.54mm



DS1073
CONECTOR PLACA-CABO
PASSO 3.96mm
 (Equivalente JST VH)



DS1075
CONECTOR PLACA-CABO
PASSO 5.0/7.5mm



DS1092-07
SOQUETE BATERIA CR2032



DS1095
CONECTORES USB TIPO A
FÊMEA 90 GRAUS



DS1095-10
CONECTORES USB TIPO A
FÊMEA 180 GRAUS



DS1099
CONECTORES USB B
FÊMEA 90 GRAUS



DS1099-01
CONECTORES USB B
FÊMEA 180 GRAUS



DS1119
EURO CONECTORES
TIPO R (REVERSO)



DS1123-15
CONECTOR MODULAR
PLUG RJ45 8P8C BLINDADO



DS1129
CONECTOR MODULAR JACK
RJ45 90 GRAUS 4 PORTAS



DS1132
CONECTOR MODULAR
JACK RJ11 4P4C 90 GRAUS



DS1133
CONECTOR MODULAR
JACK RJ11 6P6C 90 GRAUS



DS1133-02
CONECTOR MODULAR
JACK RJ11 6P6C 180 GRAUS



DS1134
CONECTOR MODULAR
JACK RJ45 8P8C 90 GRAUS



DS1134-02
CONECTOR MODULAR JACK
RJ45 8P8C 90 GRAUS



DS1134-04
CONECTOR MODULAR JACK
RJ45 8P8C 90 GRAUS



DS1139-06
SOQUETE MICRO SD CARD



PC104-011
CONECTOR Passo 2,54mm
FÊMEA c/ espaçamento





DS0062 - CONECTOR AC
90 GRAUS



DS1110-25 - CONECTOR
CIRCULAR à prova d'água





KF2EDGR-3.5-3.81
Plug-in Terminal Block

	
UL	ICE
300V	250V
8A	7A

3.5/3.81mm
2-24P



KF2EDGK-3.5/3.81
Plug-in Terminal Block

	
UL	ICE
300V	250V
8A	7A
2!H6A WG	1.5mm ²

3.5/3.81mm
2-24P





KF2EDGRK-3.5/3.81
Plug-in Terminal Block

	
UL	ICE
300V	250V
8A	7A
28-16AWG	1.5mm ²

3.5/3.81mm
2-24P





KF2EDGRK-5.0-5.08
Plug-in Terminal Block

	
UL	ICE
300V	320V
10A	15A
28-12AWG	2.5mm ²

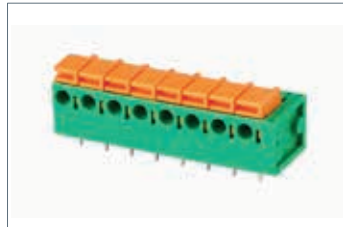
5.0/5.08mm
2-24P



KF142R-5.08 PCB
Spring Terminal Block

	
UL	ICE
300V	250V
10A	14A
22-14AWG	1.5mm ²

5.08mm
1-xxP





KF2EDGV-3.5-3.81
Plug-in Terminal Block

	
UL	ICE
300V	250V
8A	7A

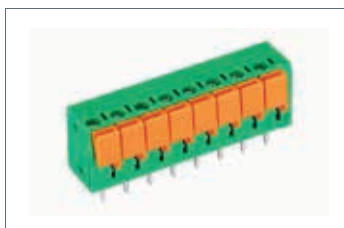
3.5/3.81mm
2-24P



KF142V-5.08 PCB
Spring Terminal Block

	
UL	ICE
300V	250V
10A	24A
22-14AWG	1.5mm ²

5.08mm
1-xxP



KF141R-2.54 PCB
Spring Terminal Block

	
UL	ICE
150V	130V
2A	6A
26-20AWG	1mm ²

2.54mm
1-xxP



PSA2.5
Transformer Terminal Block

	
UL	ICE
300V	250V
10A	24A
24-14AWG	2.5mm ²

7.5mm
2P-3 P



KF2EDGK-5.0-5.08
Plug-in Terminal Block

UL	ICE
300V	320V
10A	15A
28-12AWG	2.5mm ²

5.0/5.08mm
2-24P



KF2EDGKB-5.0-5.08
Plug-in Terminal Block

UL	ICE
300V	3320V
10A	15A
28-12AWG	2.5mm ²

5.0/5.08mm
24



KF2EDGKD-5.0-5.08
Plug-in Terminal Block

UL	ICE
300V	3300V
10A	15A
28-12AWG	2.5mm ²

5.0/5.08mm
2-24P



KF2EDGV-5.0-5.08
Plug-in Terminal Block

UL	ICE
300V	300V
10A	15A

5.0/5.08mm
2-24P



KF2EDGR-5.0-5.08
Plug-in Terminal Block



 

UL	ICE
300V	300V
10A	15A

5.0/5.08mm
2-24P



KF2EDGB-5.0-5.08
Plug-in Terminal Block

UL	ICE
300V	300V
10A	15A

5.0/5.08mm
2-24P



KF2EDGVC-5.0-5.08
Plug-in Terminal Block

UL	ICE
300V	300V
10A	15A

5.0/5.08mm
2-24P



KF2EDGRC-5.0-5.08
Plug-in Terminal Block

UL	ICE
300V	300V
10A	15A

5.0/5.08mm
2-24P



KF2EDGWB-5.0-5.08
Plug-in Block

UL	ICE
300V	300V
10A	15A

5.0/5.08mm
2-24P



KF2EDGV-5.0-5.08
Plug-in Terminal Block

UL	ICE
300V	300V
10A	15A

5.0/5.08mm
2-24P



KF2EDGR-5.0-5.08
Plug-in Terminal Block



 

UL	ICE
300V	300V
10A	15A

5.0/5.08mm
2-24P



KF2EDGB-5.0-5.08
Plug-in Terminal Block

UL	ICE
300V	300V
10A	15A

5.0/5.08mm
2-24P



KF2EDGVC-5.0-5.08
Plug-in Terminal Block



UL
300V
10A



ICE
300V
15A

5.0/5.08mm
2-24P



KF2EDGRC-5.0-5.08
Plug-in Terminal Block



UL
300V
10A



ICE
300V
15A

5.0/5.08mm
2-24P



KF2EDGWB-5.0-5.08
Plug-in Block



UL
300V
10A



ICE
300V
15A

5.0/5.08mm
2-24P



KF301-5.0 PCB
Screw Terminal Block



UL
300V
16A
22-14AWG



ICE
250V
17A
1.5mm²

5.0mm
2P-3P

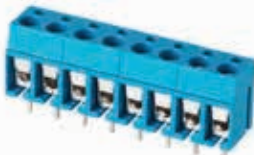

KF300-5.0 PCB
Screw Terminal Block



UL
300V
16A
22-14AWG



ICE
250V
17A
1.5mm²

5.0mm
2P - 3P



KF301 R-5.0 PCB
Screw Terminal Block



UL
300V
16A
22-14AWG



ICE
250V
17A
1.5mm²

5.0mm
2P - 3P

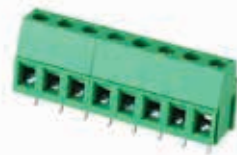

KF128L-5.0/5.08
Screw Terminal Block



UL
300V
10A
22-12AWG



ICE
250V
24A
2.5mm²

5.0/5.08 mm
2P - 3P



KF135T-10.16 PCB
Screw Terminal Block



UL
300V
57A
26-6AWG



ICE
750V
57A
1.0mm²
2P - 3P

10.16mm
2P - 3P



KF128L-3.5-3.81 PCB
Screw Terminal Block



UL
300V
10A
26-16AWG



ICE
130V
10A
1mm²



KF141V-2.54 PCB
Spring Terminal Block



UL
150V
2A
26-20AWG



ICE
130V
6A
1mm²

2.54mm
1-xxP

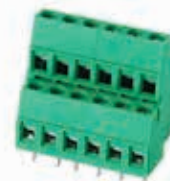

KF128A-5.0/5.08 PCB
Screw Terminal Block



UL
300V
10A
22-12AW



ICE
250V
20A
2.5mm²

5.0/5.08 mm
2P - 3P

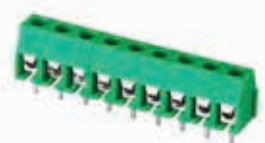

KF350 - 396-3.5/3.96 PCB
Screw Terminal Block



UL
300V
10A
24-18AWG



ICE
130V
10A
1.0mm²

3.5/3.96mm
2P - 3P



Borne de Pressão

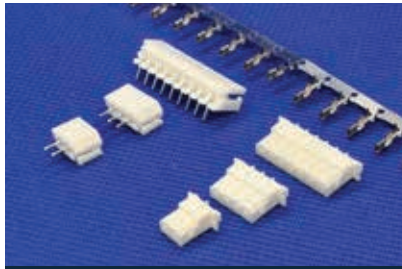

BR2503
CONECTORES PASSO 2,5mm
 (Equivalente Molex 5264/5263)

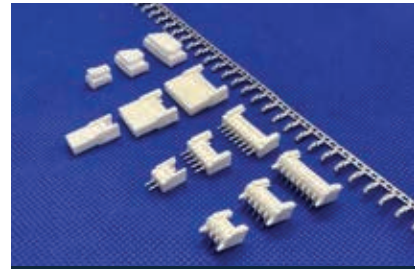

BR2010
CONECTORES PASSO 2,0mm

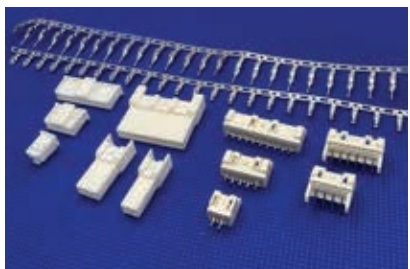

BRXA
CONECTORES PASSO 2,5mm
 (Equivalente JST XA)

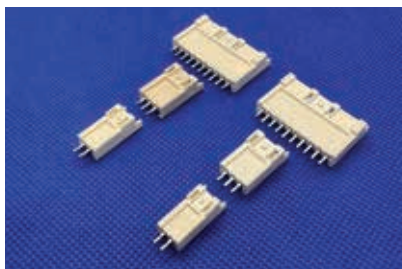

BR2508
CONECTORES PASSO 2,5mm
- LONGO
 (Equivalente JST XA-H)

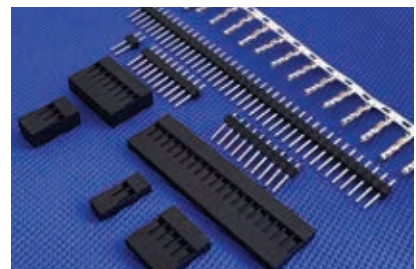

BR2540
CONECTORES PASSO 2,54mm
 (Equivalente MODU)

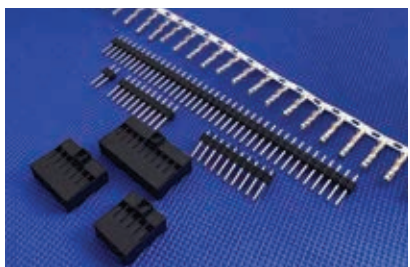

BR2544
CONECTORES PASSO 2,54mm
 (Equivalente MODU)

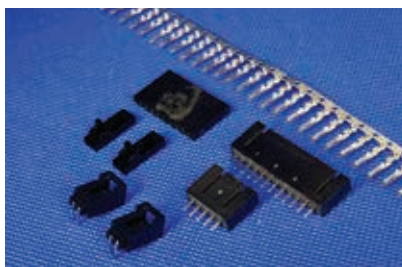

BR2545
CONECTORES PASSO 2,54mm



BR3020/BR3025/BR3030
CONECTORES PASSO 3,0mm
 (Equivalente MICRO FIT)

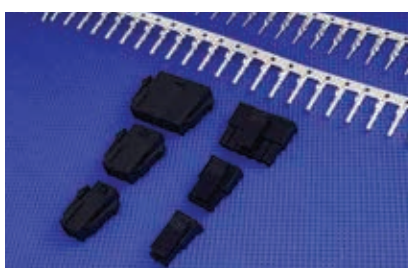

BR3022/BR3026
CONECTORES PASSO 3,0mm
FILA SIMPLES
 (Equivalente MICRO FIT)

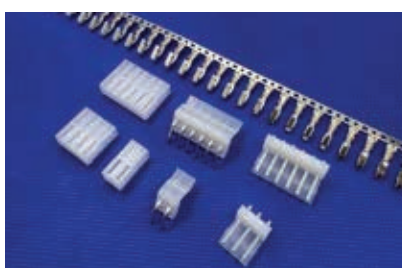

BR5072
CONECTORES PASSO 3,96mm



BR1073
CONECTORES PASSO 3,96mm
 (Equivalente JST VH)

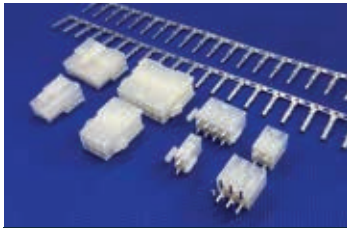

BR5557/BR5559/BR5569
CONECTORES PASSO 4,2mm
 (Equivalente MINI FIT)

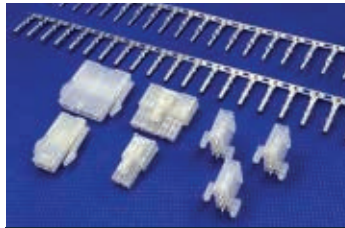

BR5557S/BR5559S
CONECTORES PASSO 4,2mm
 (Equivalente MINI FIT - Fila Simples)

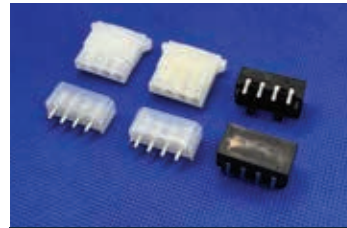

BR5080
CONECTORES PASSO 5,08mm



BR62001/BR62002
CONECTORES PASSO 6,2mm

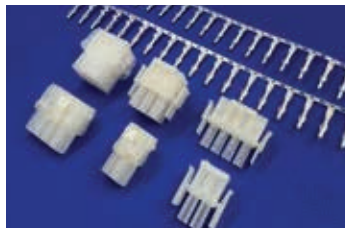

BR6350
CONECTORES PASSO 6,35mm
 (MATE-N-LOCK)



FASTON
CONECTORES PASSO 6,3mm

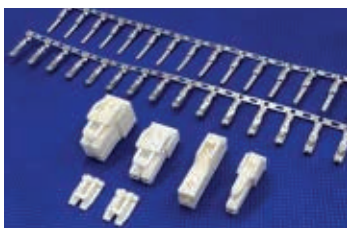

BR45002
CONECTORES PASSO 4,5mm
 (Equivalente JST YLP-YLR)



BR6201
CONECTORES PASSO 6,5mm

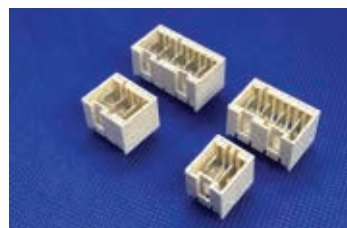

BRA
CONECTORES PCI
PASSO 5.0mm

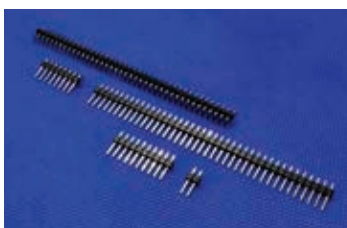

BR2540
CONECTOR BARRA DE PINO
 2,54mm 180 e 90 GRAUS

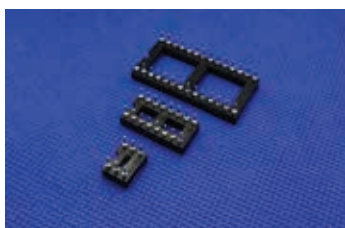

BR5001
SOQUETE TORNEADO
 06 a 40 pinos

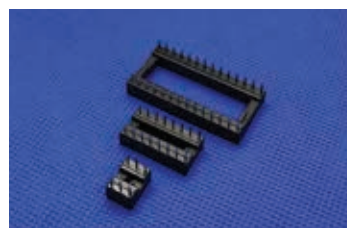

BR1009
SOQUETE ESTAMPADO
 06 A 40 pinos



ELÁSTICOS
 BR25*1,4 Elástico 25x1 ,4
 BR38*1,4 Elástico 38x1 ,4



EXTRATORES
 Mini Fit e Micro Fit p/
 terminal macho e fêmea



JVT-5500-T/IMP
TER MINAL CRIMP
 26/30 AWG P/ BATERIA



BR5011
SOQUETE PIN HEADER 2,54mm
C/ Ejetor 10 A 64 pinos

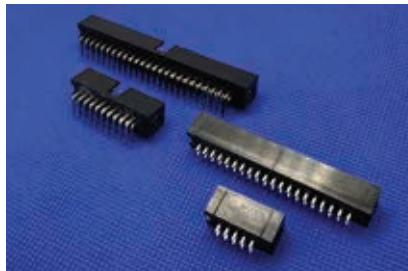

BR5013
CONECTOR BOX HEADER
2,54mm 10 A 64 pinos

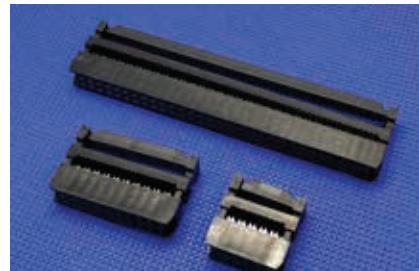

BR5016
CONECTOR IDC SOCKET
2,54mm (Equivalente LATCH)
06 a 64 pinos

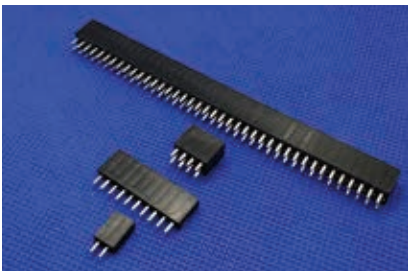

BR5023
CONECTOR PASSO 2,54mm
FÊMEA (Equivalente MCI)
180 GRAUS



BR5027
JUMPER COM E SEM HASTE
PASSO 2,54mm



BR5033
CONECTORES DB SOLDA FIO



BR5034
CONECTORES DB SOLDA PLACA



BR5035
CONECTORES HD SOLDA FIO



BR5036
CONECTORES DB PARA
FLAT CABLE

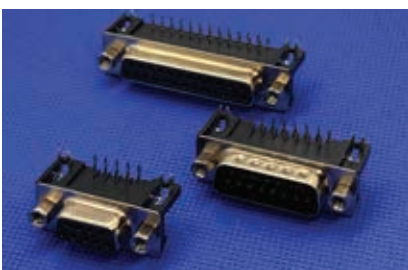

BR5037
CONECTORES DB SOLDA
PLACA 90 GRAUS

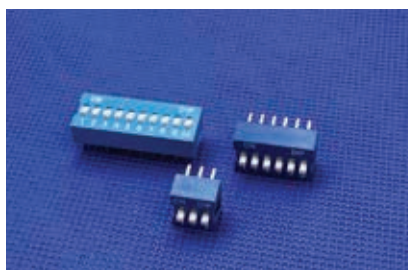

BR5040
DIP SWITCHES

Conectores Modular



Conectores BNC



USB



USB/MIKE



BR1105
Micro USB para Cabo



BR1107
USB A Macho para cabo



BR03101
USB A Macho
p/ Injeção curto



BR03103
USB A Macho p/ injeção



BR03111
USB A Fêmea
p/ injeção curto



BR03112
USB A Fêmea p/ Injeção



BR03121
USB B Macho p/ injeção



BR03141
Mini USB 5P. Macho
p/ injeção



BR03143
Mini USB 5P.
Macho p/ injeção



BR03151
Mini USB
Fêmea p/ injeção



BR03161
Micro USB
Macho p/ injeção



BR03301
HDMI Macho
p/ injeção



BR08040
Conector Micro Mike
p/cabo e painel 02-08P



BR08033
Conector Mike Fêmea
p/ cabo 02-08P



















BR08034
Conector Mike Macho
p/ painel 02-08P



BR08036
Conector Mike
Macho p/ cabo 02-08P

Plug Áudio

				
<p>BR01001 2.5mm Plug P-1 mono Plástico c/ mola</p> <p>BR01009 3.5mm Plug P-2 mono Plástico c/ mola</p>	<p>BR01002 2.5mm Plug P-1 stereo Plástico c/ mola</p> <p>BR01010 3.5mm Plug P-2 stereo Plástico c/ mola</p>	<p>BR01002-4C 2.5mm 4C Plug Plástico c/ mola</p> <p>BR01010-4C 3.5mm 4C Plug Plástico c/ mola</p>	<p>BR01003 2.5mm Plug P-1 mono</p> <p>BR01011 3.5mm Plug P-2 mono</p>	
				
<p>BR01004 2.5mm Plug P-1 stereo</p> <p>BR01012 3.5mm Plug P-2 stereo</p>	<p>BR01007 2.5mm Plug P-1 mono Metal c/ mola</p> <p>BR01015 3.5mm Plug P-2 mono Metal c/ mola</p>	<p>BR01008 2.5mm Plug P-1 stereo Metal c/ mola</p> <p>BR01016 3.5mm Plug P-2 stereo Metal c/ mola</p>	<p>BR01019 6.35mm Plug P-10 mono Plástico c/ mola</p>	
				
<p>BR01020 6.35mm Plug P-10 stereo Plástico c/ mola</p>	<p>BR01021 6.35mm Plug P-10 mono</p>	<p>BR01022 6.35mm Plug P-10 stereo</p>	<p>BR01023 6.35mm Plug P-10 mono Metal c/ mola</p>	
				
<p>BR01024 6.35mm Plug P-10 stereo Metal c/ mola</p>	<p>BR08001 Cannon Plug Femea</p>	<p>BR08002 Cannon Plug Macho</p>	<p>BR01058 6.35mm mono Plug Metal, right angle</p>	<p>BR01059 6.35mm Stereo Plug Metal, right angle</p>

Plug Injeção



BR03051
2.5mm Mono Plug



BR03053
3.5mm Mono Plug



BR03055
3.5mm 4C Plug



BR03057
6.35mm Stereo Plug



BR03060
6.35mm Mono Jack

BR03061
6.35mm Stereo Jack



BR03052
2.5mm Stereo Plug



BR03054
3.5mm Stereo Plug



BR03056
6.35mm Mono Plug



BR03058
3.5mm Mono Jack

BR03059
3.5mm Stereo Jack



BR2318
Plug DC tipo Furk
2,1/2,5mm

Jack Áudio



BR01063
A: 2.5mm J-1 mono jack
B: 2.5mm J-1 stereo jack
Plástico c/mola



BR01066
A: 2.5mm J-1 mono jack
B: 2.5mm J-1 stereo jack
Plástico c/mola



BR01068
A: 3.5mm J-2 mono jack
B: 3.5mm J-2 stereo jack
Plástico c/mola



BR01069
A: 3.5mm J-1 mono jack
B: 3.5mm J-1 stereo jack
Metal c/mola



BR01073
A: 6.35mm J-1 mono jack
B: 6.35mm J-1 stereo jack
Plástica c/mola



BR01074
A: 6.35mm J-1 mono jack
B: 6.35mm J-1 stereo jack



BR01076
A: 6.35mm J-1 mono jack
B: 6.35mm J-1 stereo jack

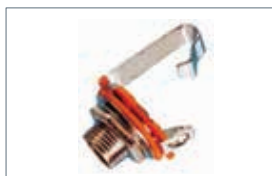

BR02004
6.35mm mono jack
close circuit







BR02005
A: 6.35mm mono jack
close circuit



BR02006
6.35mm stereo jack
open circuit

Jack Áudio

				
<p>BR02007 6.35mm stereo jack close circuit</p>	<p>BR02012 A: 2.5mm mono jack B: 3.5mm mono jack</p>	<p>BR02013 3.5mm stereo jack</p>	<p>BR02044 3.5mm stereo jack</p>	<p>BR307 Jack 3.5mm stereo 5pin pcb</p>





Plug DC e Jack DC

			
<p>BR03003 Dc Plug A: 2. 1x5. 5x9. 0mm B: 2. 5x5. 5x9. 0mm</p>	<p>BR03004 Dc Plug W/Cable protector A: 2. 1x5. 5x9. 0mm V: 2. 5x5. 5x9. 0mm</p>	<p>BR03005 Dc Plug A: 2. 1x5. 5x14. 0mm B: 2. 5x5. 5x14. 0mm</p>	<p>BR03006 Dc Plug W/Cable protector A: 2. 1x5. 5x14. 0mm B: 2. 5x5. 5x14. 0mm C: 2. 8x5. 5x14. 0mm D: 1. 35x3. 5x14. 0mm</p>
			
<p>BR03013 Dc Jack P.C.B layout A: 2. 1x5. 5mm B: 2. 5x5. 5mm</p>	<p>BR03014 Dc Jack P.C.B layout A: 2. 1x5. 5mm B: 2. 5x5. 5mm</p>	<p>BR03015 Dc Jack A: 2. 1x5. 5mm B: 2. 5x5. 5mm</p>	<p>BR03018 Dc chassis jack A: 2. 1x5. 5mm B: 2. 5x5. 5mm</p>
			
<p>BR02323 Dc Power Jack A: Pin OD: 2.1mm B: Pin OD: 2.5mm</p>	<p>BR03027 Dc Power Jack A: Pin OD: 2.1mm B: Pin OD: 2.5mm</p>	<p>BR03029 Dc chassis jack A: 2. 1x5. 5mm B: 2. 5x5. 5mm</p>	<p>BR03030A Dc Jack Female 5. 5x2.1mm p/ injeção</p> <p>BR03030B Dc Jack Female 5. 5x2.5mm p/ injeção</p>



Plug Mini Din/Din

				
<p>BR11014 Plug Mini Din Macho (3P-8P)</p>	<p>BR11015 Plug Mini Din Fêmea (3P-8P)</p>	<p>BR11017 Plug Din Macho P/ injeção (3P-8P)</p>	<p>BR11020 Plug Mini Din Macho P/ injeção (3P-8P)</p>	<p>BR211131 Mini Din Socket 4Pin-10Pin A: half Shield B: full Shield</p>

Interruptores

				
<p>BR-KDC1-101-5</p>	<p>BR-KCD1-101-8</p>	<p>BR-KCD2-101-3</p>	<p>BR-R13-507-BK</p>	<p>BR-KCD4-201 sem neon BR-KCD4-201N com neon</p>

Porta Fusível

		
<p>BR16022 Porta Fusível A: 5mmx20mm B: 6mmx30mm</p>	<p>BR15041 Porta Fusível A: 5mmx20mm B: 6mmx30mm</p>	<p>BR1540/BR1550 Porta Fusível 5x20mm para pci com tampa fixa/sem tampa</p>

**Clip de
bateria**

<p>BR140041-T Clip Bateria 9V Tipo T</p>

<p>BR140040-I Clip Bateria 9V Tipo I</p>

<p>BR13004 Plug acendedor Auto c/ Led</p>

Plug

Tactil Switches



TACTIL SWITCH
6X6 180° DIP



TACTIL SWITCH
6X6 90° DIP



TACTIL SWITCH
6X6 SMD



TACTIL SWITCH
12X12 DIP



TACTIL SWITCH
6X6 SMD

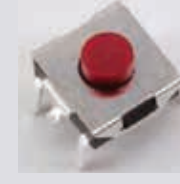

TACTIL SWITCH
6X6 DIP

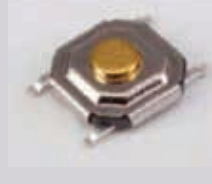

TACTIL SWITCH
5X5 SMD



TACTIL SWITCH
3,5X6 SMD

Ferramentas - Alicates e decapadores



SNA-01BM
CRIMPAR FIOS DE
28-22AWG



SN-2
CRIMPAR FIOS DE
26-18AWG



SN-48B
CRIMPAR FIOS DE
18-14AWG



SN-02C
CRIMPAR PRÉ-ISOLADOS
22-12AWG



HS-065
ALICATE DE CORTE
35mm



VH4-06WFL
CRIMPAR ILHÓS
0,50-6,0mm



HS-600A
ALICATE PARA
ABRAÇADEIRA 2.4-4.8mm



VH4-06WFL
CRIMPAR ILHÓS
0,50-6,0mm

Ferramentas - Alicates e decapadores



HT-208M
CRIMPAR MODULAR
PLUG RJ45/8-8C



TL-568R
PLUG RJ11/12/45
6P4C/6P6C/8P8C



LY-214
CRIMPAR CONECTORES I.D.C.
(FLAT CABLE)



HSC8-6-6
CRIMPAR ILHÓS
0,50 - 6,0mm



FS-D3
DECAPA E CORTA FIOS
0,08-2,5mm



HS-700D
DECAPA E CORTA FIOS
0,25MM-2,5mm



HS-700B
DECAPA FIOS
0.25-6.0mm



HS-109
MINI ALICATE DE CORTE DIAGONAL
COM MOLA P/ FIOS ATÉ 1,0mm



VH5-03BC
ALICATE PARA CRIMP TERMINAL
(FASTON) 20-10AWG

Terminais Pré Isolados

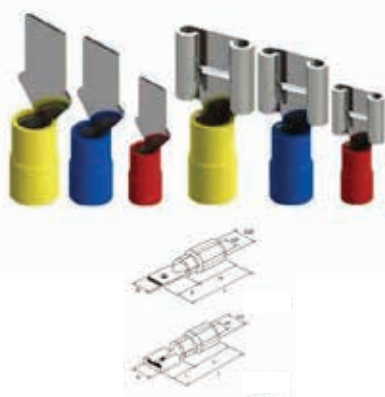

TERMINAIS PRÉ ISOLADOS MACHO E FÊMEA 2,8 - 4,8 - 6,3MM

CÓDIGO	BITOLA (MM ² / AWG)	B	L	F	H	D	d	COR
BR-MDD1.25-250-BR-B	0.3-1.5 / 22-16	6.35	21.0	7.9	10.0	3.8	1.7	Vermelho
BR-MDD2-250-BR-B	1.5-2.5 / 14-16	6.35	21.0	7.9	10.0	4.3	2.3	Azul
BR-MDD5.5-250-BR-B	4.0-6.0 / 12-10	6.35	25.0	7.9	12.5	5.7	3.4	Amarelo
BR-FDD1.25-110-BR-B	0.3-1.5 / 22-16	3.8	19.0	6.4	-	3.8	1.7	Vermelho
BR-FDD1.25-187-BR-B	0.3-1.5 / 22-16	5.6	19.0	6.5	10.0	3.8	1.7	Vermelho
BR-FDD1.25-250-BR-B	0.3-1.5 / 22-16	7.4	21.0	7.9	-	-	-	Vermelho
BR-FDD2-110-BR-B	1.5-2.5 / 14-16	3.8	19.0	6.4	-	4.3	2.3	Azul
BR-FDD2-187-BR-B	1.5-2.5 / 14-16	5.6	19.0	6.5	10.0	-	-	Azul
BR-FDD2-250-BR-B	1.5-2.5 / 14-16	7.4	21.0	7.9	-	-	-	Azul
BR-FDD5.50-250-BR-B	4.0-6.0 / 12-10	7.4	25.0	7.9	12.5	5.7	3.4	Amarelo

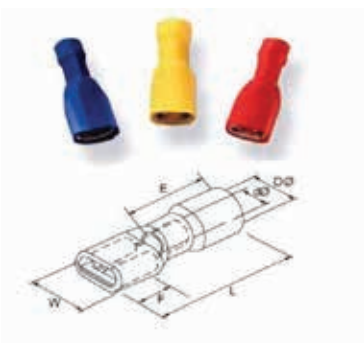

TERMINAL PRÉ ISOLADOS FÊMEA 6,3MM TODO ISOLADO

BITOLA	BITOLA (MM ² / AWG)	B	L	F	H	D	d	COR
BR-FDFD1.25-250-BR-B	0.3-1.5 / 22-16	7.4	21.5	7.9	10.0	2.7	1.7	Vermelho
BR-FDFD2-250-BR-B	1.5-2.5 / 14-16	7.4	21.5	7.9	10.0	3.3	2.3	Azul
BR-FDFD5.5-250-BR-B	4.0-6.0 / 12-10	7.4	25.5	7.9	14.0	4.5	3.4	Amarelo



TERMINAL PRÉ-ISOLADO ILHÓS

CÓDIGO	AWG	MM ²	F	L	W	B	D	C	COR
BR-E0508-WH	20	0.5	8.0	12.0	2.6	6.0	1.3	1.0	Branco
BR-E7508-GY	18	0.75	8.0	14.6	2.8	6.4	1.5	1.2	Cinza
BR-E1008-RD	16	1.0	8.0	14.6	3.0	6.4	1.7	1.4	Vermelho
BR-E1508-BK	14	1.5	8.0	14.6	3.5	6.4	1.7	1.7	Preto
BR-E2508-BL	12	2.5	8.0	15.2	4.0	7.0	2.6	2.3	Azul
BR-E4012-GY	10	4.0	12.0	19.5	4.4	7.5	3.2	2.8	Cinza
BR-E6012-YL	8	6.0	12.0	20.0	6.3	8.0	3.9	3.5	Amarelo
BR-E1012-RD	-	10.0	12.0	21.5	7.6	9.5	4.9	4.5	Vermelho
BR-E1612-BL	-	16.0	12.0	22.2	8.8	10.2	6.2	5.8	Azul
BR-E2516-YE	-	25.0	16.0	29.0	11.2	13.0	7.9	7.5	Amarelo
BR-E3516-RD	-	35.0	16.0	30.0	12.7	14.0	8.7	8.3	Vermelho
BR-E5025-BL	-	50.0	25.0	41.0	16.0	15.0	10.9	10.3	Azul



TERMINAL PRÉ-ISOLADO ILHÓS DUPLO

CÓDIGO	AWG	MM ²	F	L	W	B	D	C	COR
BR-TE0508-WH	2X20	2 X 0.5	8.0	14.5	5.0	6.5	1.8	1.5	Branco
BR-TE7508-GY	2X18	2 X 0.75	8.0	14.7	5.5	6.7	2.1	1.8	Cinza
BR-TE1008-RD	2X16	2 X 1.00	8.0	15.1	5.5	7.1	2.3	2.0	Vermelho
BR-TE1508-BK	2X14	2 X 1.5	8.0	15.5	6.4	7.2	2.6	1.7	Preto
BR-TE2510-GY	2X12	2 X 2.5	10.0	18.5	8.0	8.5	3.3	2.9	Cinza
BR-TE2510-BL	2X12	2 X 2.5	10.0	18.5	8.0	8.5	3.3	2.9	Azul
BR-TE4012-GY	2X10	2 X 4.0	12.0	23.1	8.8	11.1	4.2	3.8	Cinza
BR-TE6014-YL	2x8	2 X 6.0	14.0	26.1	9.5	12.1	5.3	4.9	Amarelo

Terminais Pré Isolados



TERMINAL PRÉ-ISOLADO PINOS

CÓDIGO	BITOLA (MM ² / AWG)	L	F0	E	D0	d0	COR
BR-PTV1.25-10-BR	0.3-1.5 / 22-16	19.0	1.9	10.0	4.3	1.5	Vermelho
BR-PTV1.25-13-BR-B	0.3-1.5 / 22-16	23.0	1.9	10.0	4.3	1.5	Vermelho
BR-PTV2-10-BR-B	1.5-2.5 / 16-14	20.0	1.9	10.0	4.9	2.4	Azul
BR-PTV2-13-BR-B	1.5-2.5 / 16-14	23.0	1.9	10.0	4.9	2.4	Azul
BR-PTV5.5-13-BR-B	4-6 / 12-10	25.2	7.5	12.5	6.7	4.0	Amarelo



TERMINAL PRÉ-ISOLADO EMENDA

CÓDIGO	BITOLA (MM ² / AWG)	L	I	d0	COR
BR-BV1.25-BR-B	0.3-1.5 / 22-16	26.0	15.0	4.4	Vermelho
BR-BV2-BR-B	1.5-2.5 / 14-16	26.0	15.0	5.1	Azul
BR-BV5.5-BR-B	4.0-6.0 / 21.4	5.9	12.5	6.7	Amarelo



TERMINAL OLHAL SEM ISOLAÇÃO

CÓDIGO	BITOLA (MM ² / AWG)	DIÂMETRO INTERNO d20	B	L	F	E	D0	d0
BR-RNBS1.25-4-BR	0.3-1.5 22-16	4.3	6.4	14.4	6.3	4.8	3.4	1.7
BR-RNBS1.25-5-BR	0.3-1.5 22-16	5.3	8.0	15.8	7.0	4.8	3.4	1.7
BR-RNB1.25-6-BR	0.3-1.5 22-16	6.4	8.0	21.8	8.5	4.8	3.4	1.7
BR-RNB1.25-8-BR	0.3-1.5 22-16	8.4	11.6	21.8	11.1	4.8	3.4	1.7
BR-RNB2-3.2-BR	1.5-2.5 16-14	3.2	6.6	12.3	4.3	10.0	4.9	2.4
BR-RNBS2-4-BR	1.5-2.5 16-14	4.3	6.6	16.0	7.0	10.0	4.9	2.4
BR-RNBS2-5-BR	1.5-2.5 16-14	5.3	8.5	16.8	7.75	10.0	4.9	2.4
BR-RNB2-6-BR	1.5-2.5 16-14	6.4	12.0	21.8	11.0	10.0	4.9	2.4
BR-RNB2-8-BR	1.5-2.5 16-14	8.4	12.0	27.6	11.0	10.0	4.9	2.4
BR-RNBSS5.5-4-BR	4-6 12-10	4.3	7.2	15.7	5.9	6.8	5.6	3.4
BR-RNBSS5.5-5-BR	4-6 12-10	5.3	9.5	19.8	8.3	6.8	5.6	3.4
BR-RNBSS5.5-6-BR	4-6 12-10	6.4	12.0	25.8	13.0	6.8	5.6	3.4

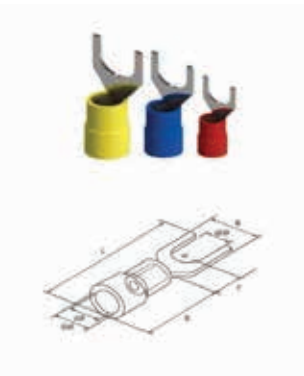

TERMINAL PRÉ-ISOLADO FORQUILHA

CÓDIGO	BITOLA (MM ² / AWG)	DIÂMETRO INTERNO d20	B	L	F	E	d0	D0	COR
BR-SV1.25-3.2-BR-B	0.3-1.5 / 22-16	3.2	5.7	21.2	6.5	10.0	4.3	1.8	Vermelho
BR-SVS1.25-4-BR-B	0.3-1.5 / 22-16	4.3	6.4	21.2	6.5	10.0	4.3	1.8	Vermelho
BR-SVS1.25-5-BR-B	0.3-1.5 / 22-16	5.3	8.1	21.2	6.5	10.0	4.3	1.8	Vermelho
BR-SVS1.25-6-BR-B	0.3-1.5 / 22-16	6.5	9.5	21.2	6.5	10.0	4.3	1.8	Vermelho
BR-SV2-3.2-BR-B	1.5-2.5 / 16-14	3.2	5.0	21.2	6.5	10.0	4.9	2.4	Azul
BR-SVS2-4-BR-B	1.5-2.5 / 16-14	4.3	6.0	21.2	6.5	10.0	4.9	2.4	Azul
BR-SVL2-5-BR-B	1.5-2.5 / 16-14	5.3	9.0	21.2	6.5	10.0	4.9	2.4	Azul
BR-SVL2-6-BR-B	1.5-2.5 / 16-14	6.5	12.0	27.2	11.0	10.0	4.9	2.4	Azul
BR-SVS5.5-4-BR-B	4-6 / 12-10	4.3	8.3	25.2	7.5	12.5	6.7	4.0	Amarelo
BR-SVS5.5-5-BR-B	4-6 / 12-10	5.3	9.0	23.9	7.5	12.5	6.7	4.0	Amarelo
BR-SVS5.5-6-BR-B	4-6 / 12-10	6.5	9.0	23.9	7.5	12.5	6.7	4.0	Amarelo



TERMINAL PRÉ-ISOLADO OLHAL

CÓDIGO	BITOLA MM ² / AWG	DIÂMETRO INTERNO d20	B	L	F	E	d0	D0	COR
BR-RV1.25-3.2-BR-B	0.3-1.5 / 22-16	3.2	5.7	17.8	4.95	10.0	4.3	1.8	Vermelho
BR-RV1.25-4-BR-B	0.3-1.5 / 22-16	4.3	8.0	21.5	7.0	10.0	4.3	1.8	Vermelho
BR-RV1.25-5-BR-B	0.3-1.5 / 22-16	5.3	8.0	21.5	7.0	10.0	4.3	1.8	Vermelho
BR-RV1.25-6-BR-B	0.3-1.5 / 22-16	6.5	8.0	21.5	7.0	10.0	4.3	1.8	Vermelho
BR-RV1.25-8-BR-B	0.3-1.5 / 22-16	8.4	11.6	27.5	11.1	10.0	4.3	1.8	Vermelho
BR-RV1.25-10-BR-B	0.3-1.5 / 22-16	10.5	11.6	27.5	11.1	10.0	4.3	1.8	Vermelho
BR-RV2-3.2-BR-B	1.5-2.5 / 16-14	3.2	6.6	17.8	4.3	10.0	4.9	2.4	Azul
BR-RV2-4-BR-B	1.5-2.5 / 16-14	4.3	6.6	21.0	7.0	10.0	4.9	2.4	Azul
BR-RV2-5-BR-B	1.5-2.5 / 16-14	5.3	8.5	22.5	7.75	10.0	4.9	2.4	Azul
BR-RV2-6-BR-B	1.5-2.5 / 16-14	6.5	12.0	27.6	11.0	10.0	4.9	2.4	Azul
BR-RV2-8-BR-B	1.5-2.5 / 16-14	8.4	12.0	27.6	11.0	10.0	4.9	2.4	Azul
BR-RV2-10-BR-B	1.5-2.5 / 16-14	10.5	13.6	30.2	13.9	10.0	4.9	2.4	Azul
BR-RV5.5-3.7-BR-B	4-6 / 12-10	3.7	7.2	21.4	5.9	12.5	6.7	4.0	Amarelo
BR-RV5.5-4-BR-B	4-6 / 12-10	4.3	7.2	21.4	5.9	12.5	6.7	4.0	Amarelo
BR-RV5.5-5-BR-B	4-6 / 12-10	5.3	9.5	25.5	8.3	12.5	6.7	4.0	Amarelo
BR-RV5.5-6-BR-B	4-6 / 12-10	6.5	12.0	31.5	13.0	12.5	6.7	4.0	Amarelo
BR-RV5.5-8-BR-B	4-6 / 12-10	8.4	15.0	33.7	13.7	12.5	6.7	4.0	Amarelo

ABRAÇADEIRA NYLON

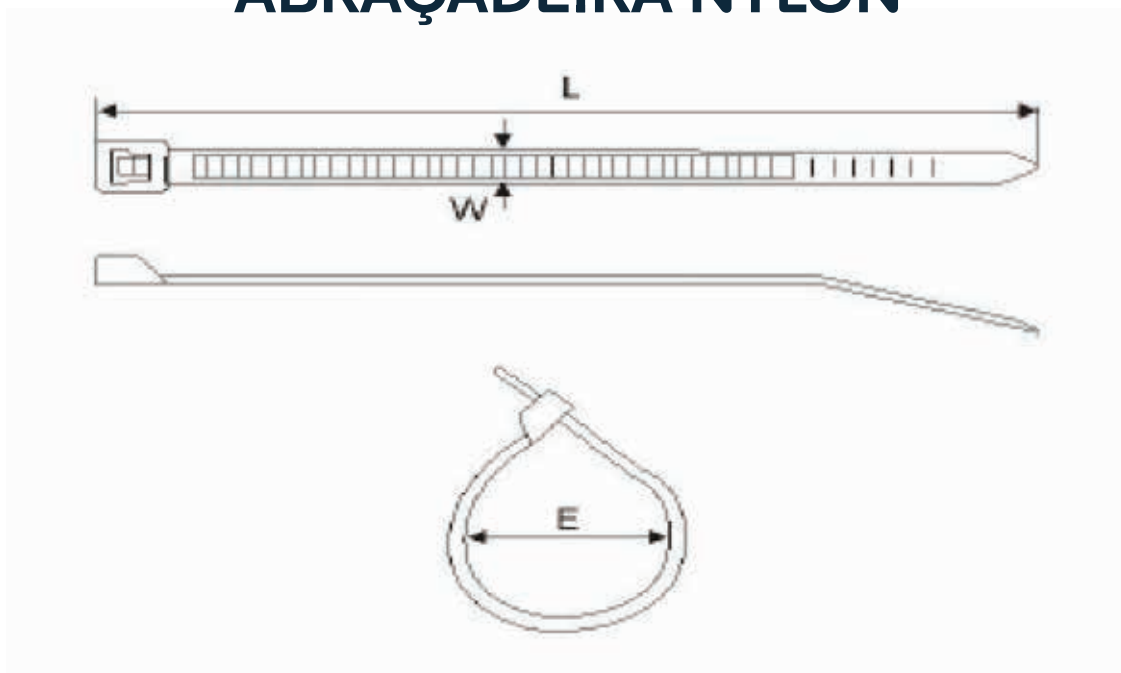

Material:

Nylon 66, 94V-2 certificado UL, resistente ao calor, isola bem e não envelhecem.

Facil de utilização, manual ou com ferramenta.

Temperatura de operação: -40°C + 85°C

Cor:

BRANCA (NATURAL), PRETA, e outras cores sob encomenda.

Embalagem: Pacote com 100 pçs

MODELO	L mm	W mm	E (mm) Diâmetro máximo feixe	Tensão mínima a ruptura KGs
BR2.5X100	100	2.5	22	8
BR2.5X150	150	2.5	35	8
BR2.5X200	200	2.5	50	8
BR3.6X150	150	3.5	35	18
BR3.6X200	150	3.5	50	18
BR4.8X200	200	4.8	50	22
BR4.8X300	300	4.8	80	22
BR4.8X400	400	4.8	105	22
BR7.6X400	400	7.6	105	55

Quick Splice

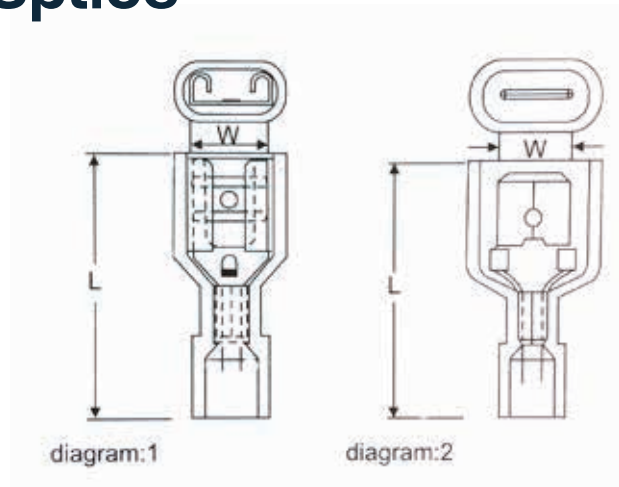
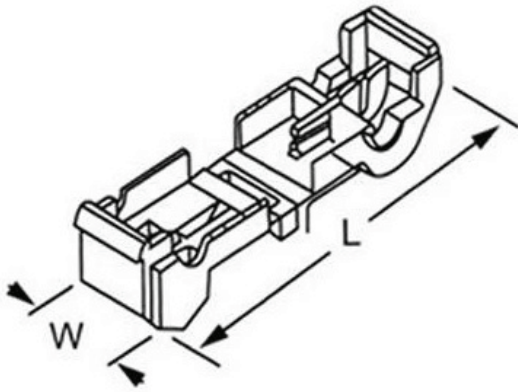

Fio Bitola AWG mm ²	Cod Conector	Dimensão (mm)		Cod Terminal Macho e fêmea	Dimensão (mm)		Cor
		W	L		W	L	
22-18 A.W.G 0.5-0.75 mm ²	 BR878-1.25-250	0.366 9.3	1.583 40.2	 FDFNY-1.25-250	6.6 6.35	22.0 23.0	Vermelho
18-14 A.W.G 0.75-2.5 mm ²	 BR878-2-250	0.366 9.3	1.583 40.2	 MDFNY-2-250 FDFNY-2-250	6.6 6.35	23.0 24.0	Azul
12 A.W.G 4 mm ²	 BR878-5.5-250	0.366 9.3	1.583 40.2	 MDFNY-5.5-250 FDFNY-5.5-250	6.6 6.35	23.0 24.0	Amarelo



Tube Termo Retrátil 2:1

Tamanhos de 1mm a 180mm - várias cores - transparentes
Padrão de segurança: US224 VM-1 C-UL CSA C22.2 OFT RoHS



Cabos para Eletro Eletrônica

Cabo Flat colorido colado



Cabo Flat colado, nas seções nominais de 28 a 16AWG, com 02 a 50 vias

Cabo Manga



Podemos atender em várias bitolas, números de vias, cores, com ou sem blindagem.



BR25041

Telephone cable (Cabo chato)
4, 6 e 8 condutores
Cores: Preto, bege, branco e prata

Conectores automotivos Macho, fêmea, terminais e isolantes



Opto **BR**

LEDs 5mm e 3mm. Transparentes ou Difusos





BREDA COMÉRCIO E IMPORTAÇÃO LTDA
Rua da Graça, 758, Bom Retiro, CEP: 01125-000, São Paulo -SP
(11) 2367-7470

vendas@bredaconectores.com.br
www.bredaconectores.com.br
facebook.com/bredaconectores